

Hardy Standing Seam Trims

**We can also
bend custom
trims to your
specs.**

**ALL Trims are 10' in
length.**

ALL STANDING SEAM TRIMS ARE NOT-RETURNABLE

New Style Standing Seam Gable Trim (Hidden Fastener, Comes with Z-Bar)

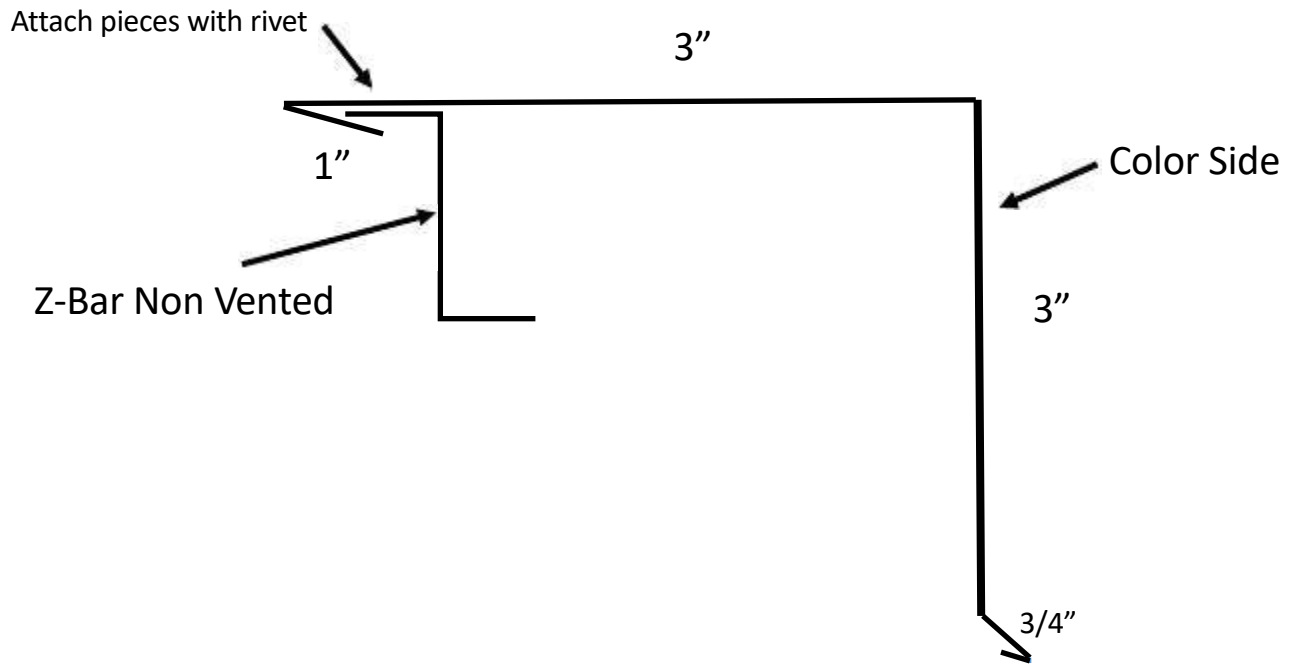

Drip Edge

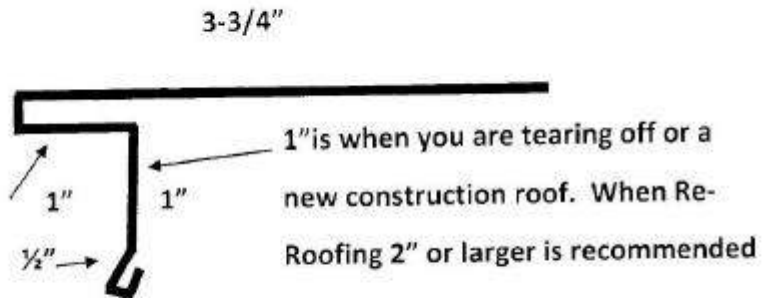

Hardy Standing Seam Trims

ALL STANDING SEAM TRIMS ARE NOT RETURNABLE

Ridge Cap

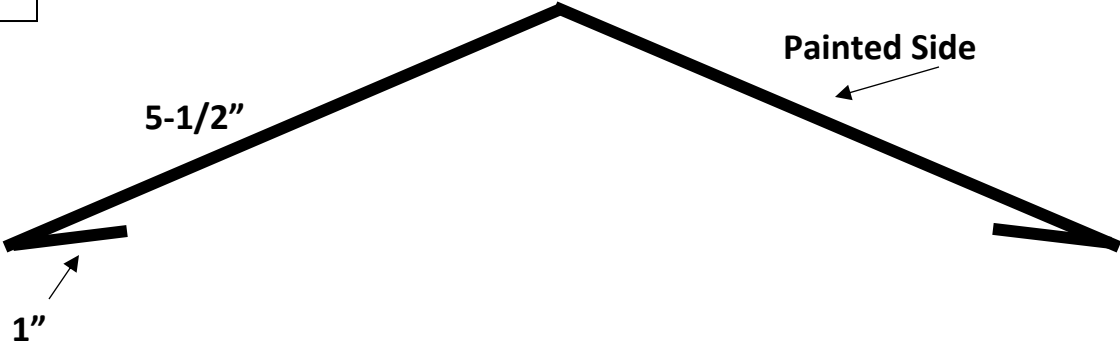

Hardy Standing Seam Trims

ALL STANDING SEAM TRIMS ARE NOT RETURNABLE

J-Channel for Ridge

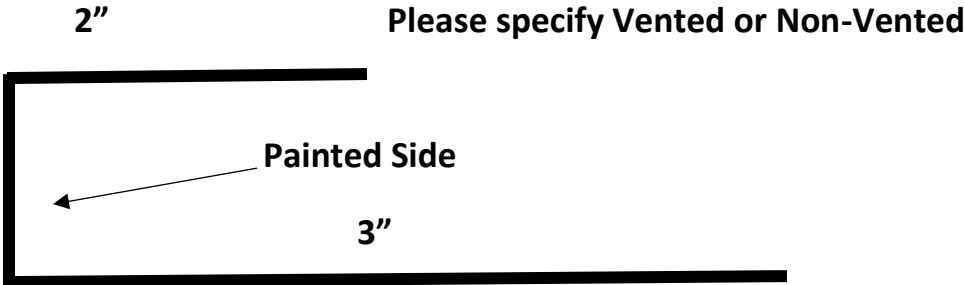

Please specify Vented or Non-Vented

HardySnap, HC-100, & Legacy HardyClip: 1-3/8"

HardyLoc, HC-150, & HS-150: 1-5/8"

Hardy Standing Seam Trims

ALL STANDING SEAM TRIMS ARE NOT RETURNABLE

Z-Bar Non-Vented

For Vented Z-bar we now carry Snap-Z in Black for all panel rib heights.

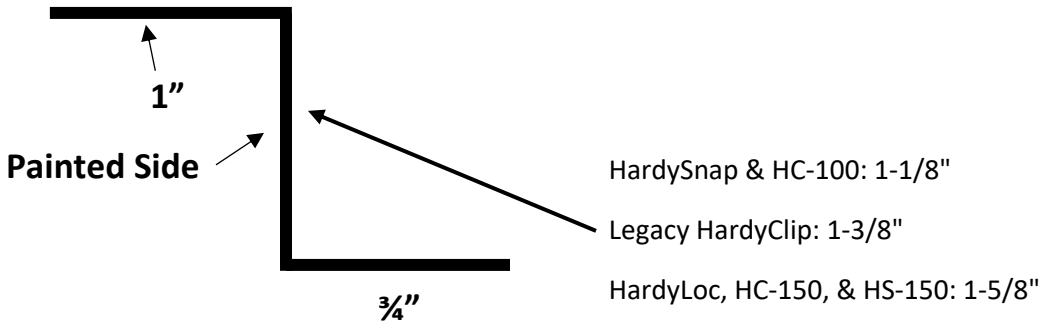

Pitch Change

Pitch Change Trim has non-vented Z Bar included

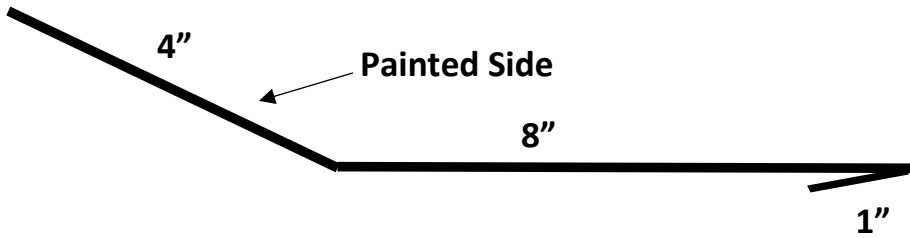

Gambrel Trim

Gambrel Trim has non-vented J-Channel included

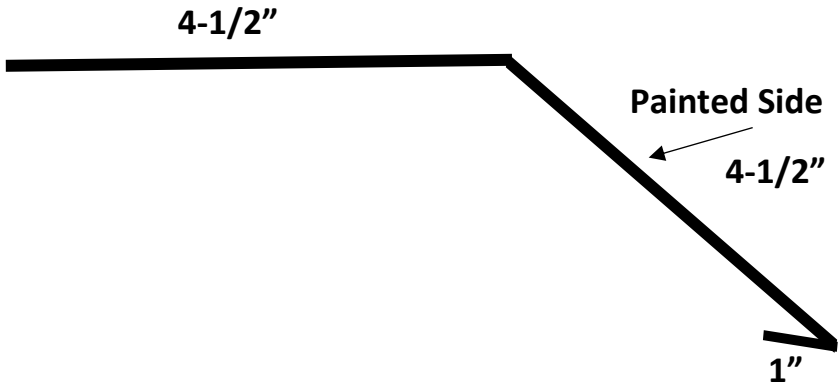

Hardy Standing Seam Trims

ALL STANDING SEAM TRIMS ARE NOT RETURNABLE

Valley can be made as a W or V style valley, please specify when ordering

Valley Pan

Recommended to use Cleats

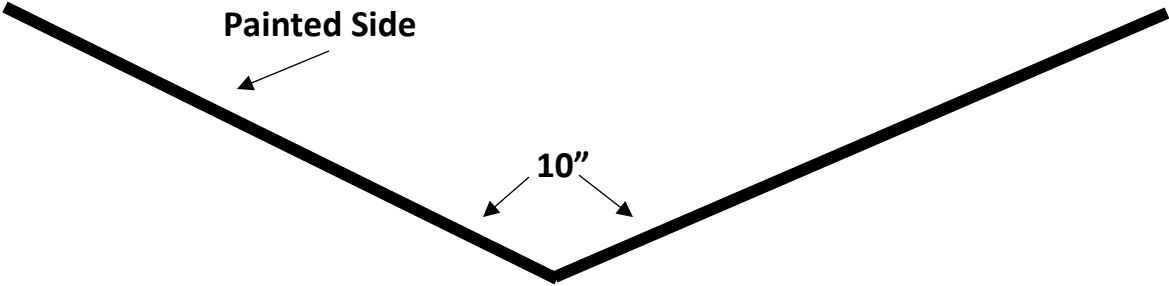

Offset Cleat

Color may not match color purchased.
Product is made from excess steel sheets

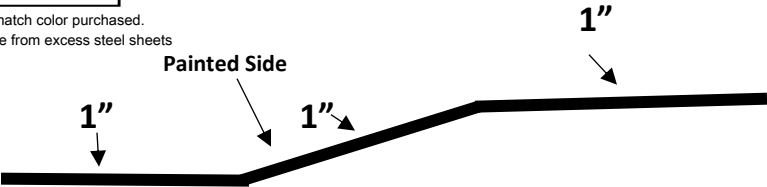

Receiver Cleat

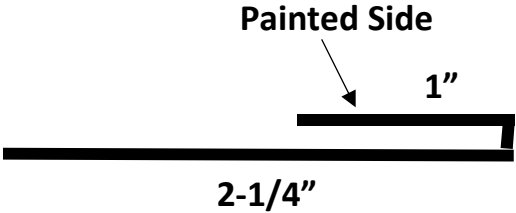

Standing Seam Sidewall Flashing w/Solid Z-Bar

(10ft Length, Hidden Fastener)

ALL STANDING SEAM TRIMS ARE NOT RETURNABLE

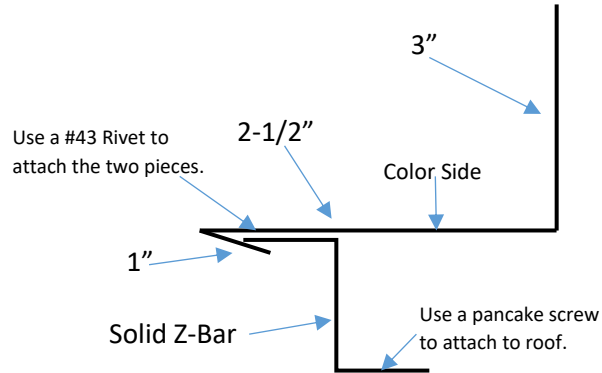

Standing Seam End/Head Wall Flashing w/Solid J-Channel

(10ft Length, Hidden Fastener)

ALL STANDING SEAM TRIMS ARE NOT RETURNABLE

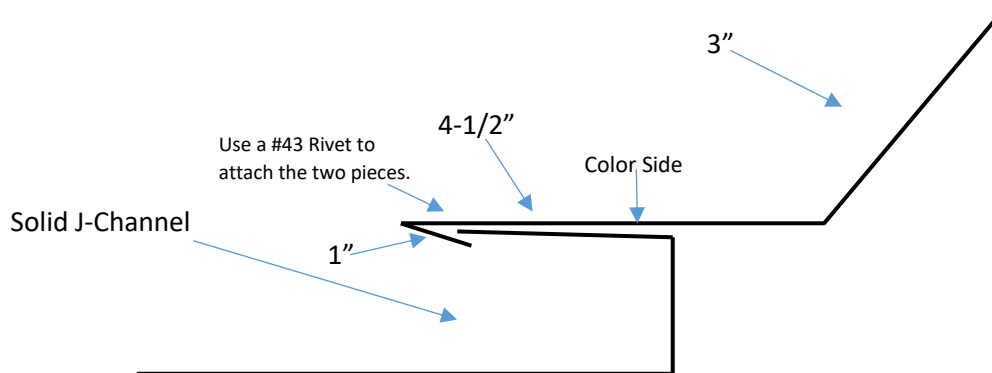

ALL STANDING SEAM TRIMS ARE NOT RETURNABLE

ALL STANDING SEAM TRIMS ARE NOT RETURNABLE

FASCIA TRIMS

NON-RETURNABLE

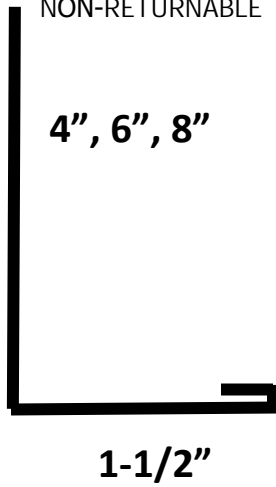

Box Gutter 29ga, 26ga, 24ga, or 22ga

NON-RETURNABLE

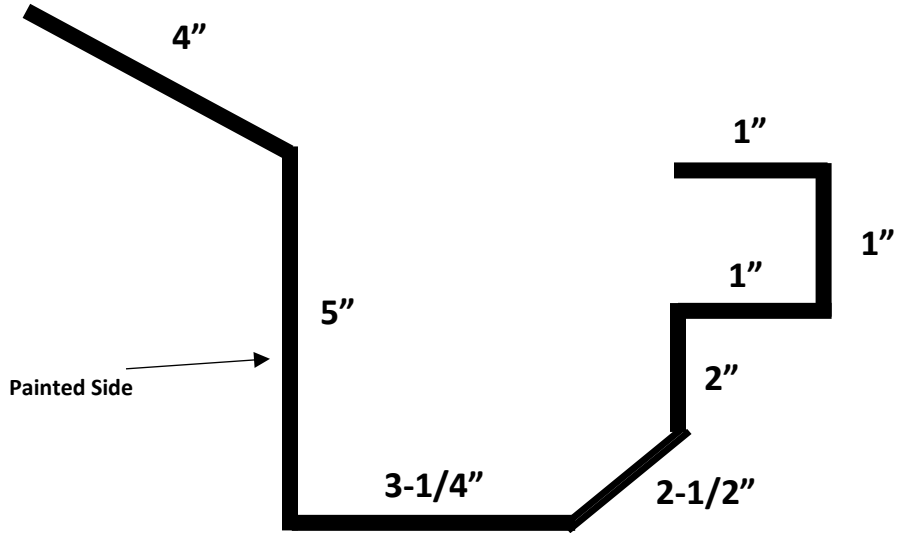

Painted Side

Does not include Ends, you will need to fabricate your own ends using a hand bender.

Standing Seam Exposed Fastener Trim

EX-New Construction Drip 10'

Non-Returnable

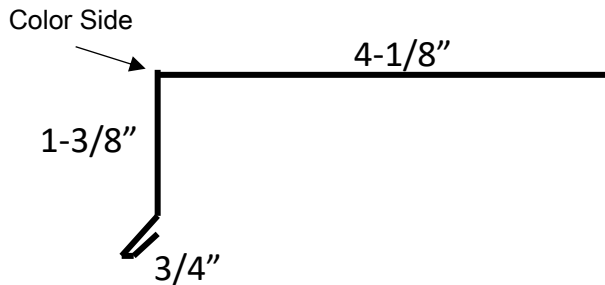

EX-Re-Roof Drip Edge 10'

Non-Returnable

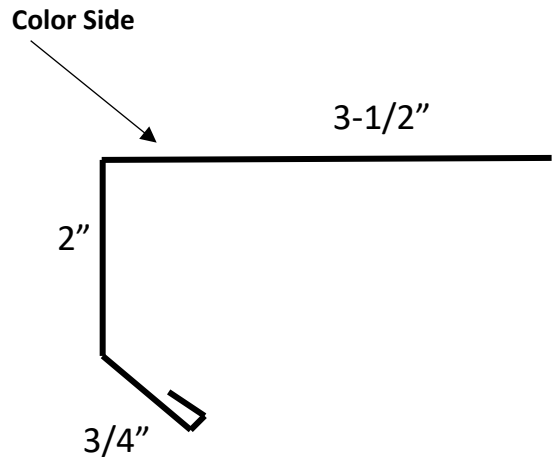

Last Updated 8/1/19

Standing Seam Exposed Fastener Trim

EX-Ridge Cap 10'

Non-Returnable

Color Side

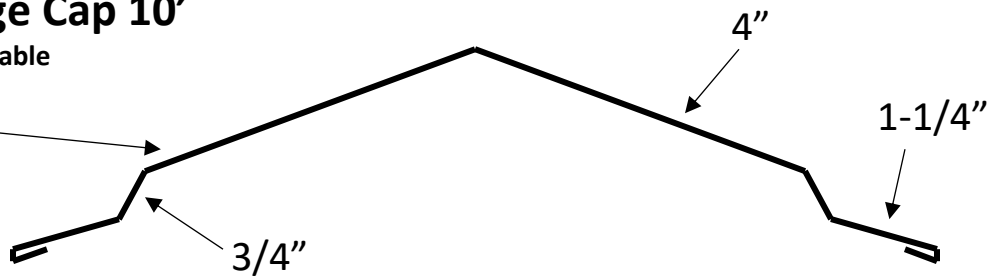

EX-Gable Trim 10'

Non-Returnable

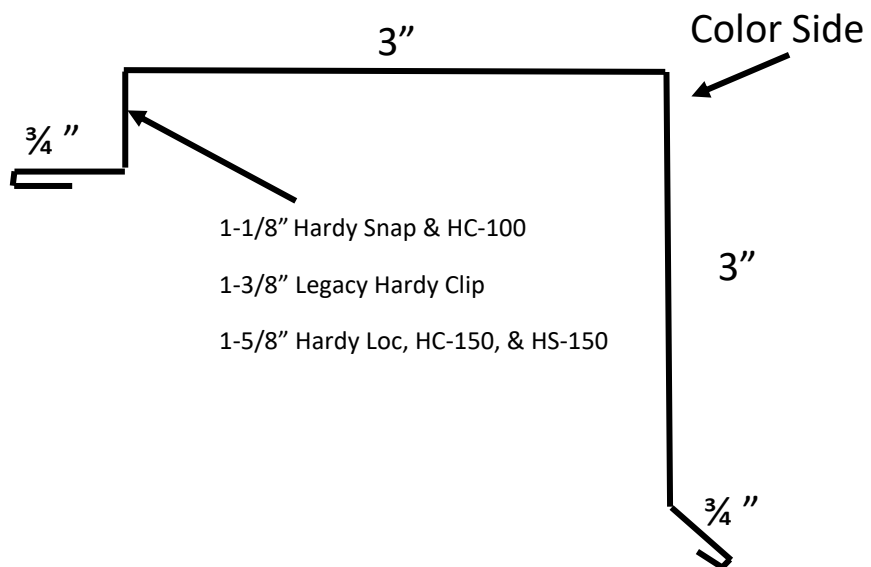

EX-Inside Transition/Pitch Break 10'

Non-Returnable

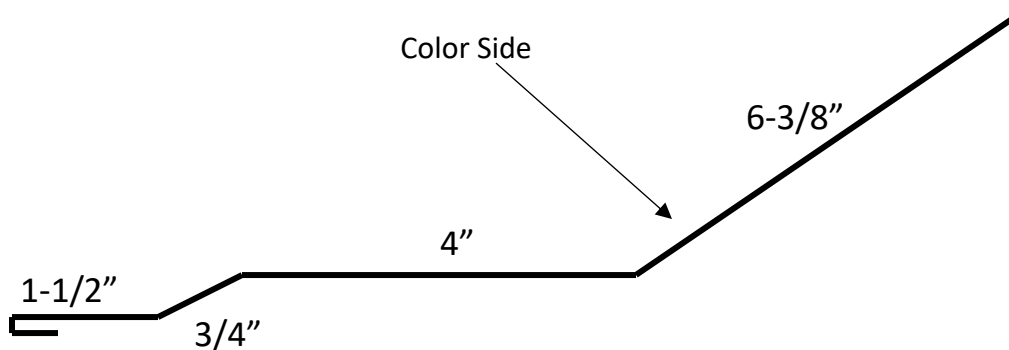

Standing Seam Exposed Fastener Trim

SS- FJ Channel 10'

Non-Returnable

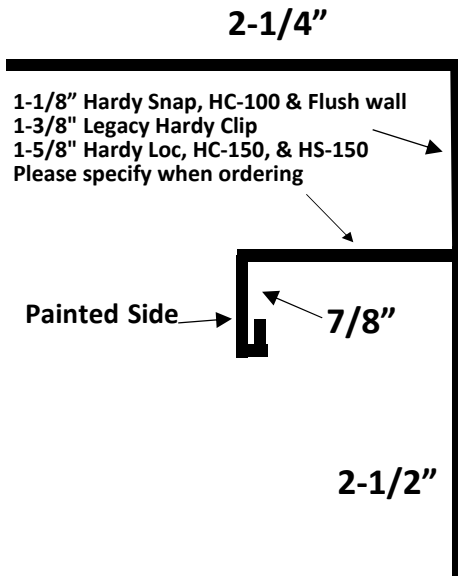

SS- J Channel 10'

Non-Returnable

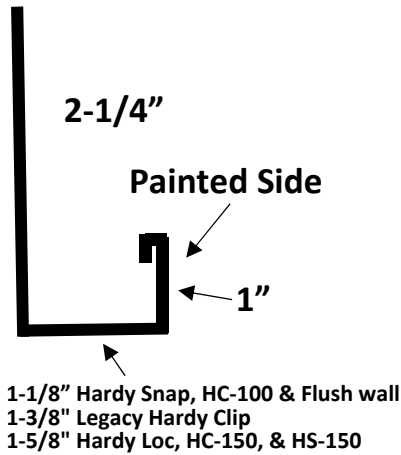

SS- 2" J Channel 10'

Non-Returnable

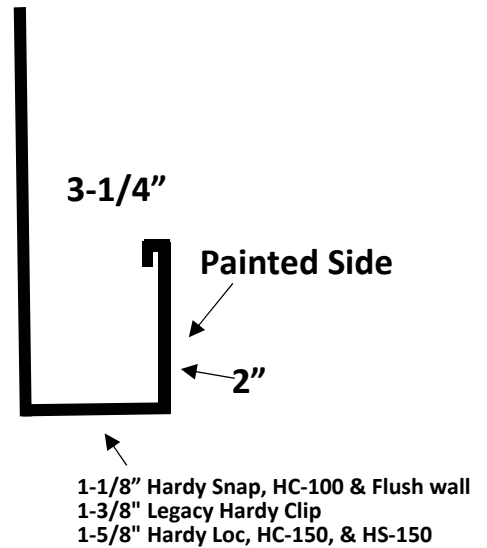

SS-Rat Guard 10'

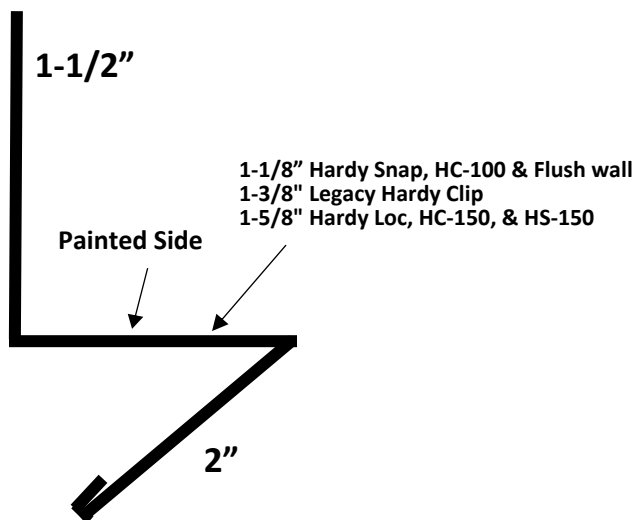

SS-Z Bar 10'

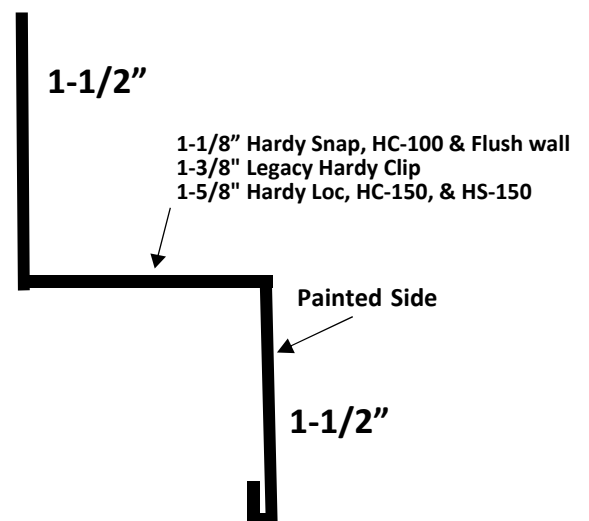

Standing Seam Exposed Fastener Trim

EX-Side Wall 10'

Non-Returnable

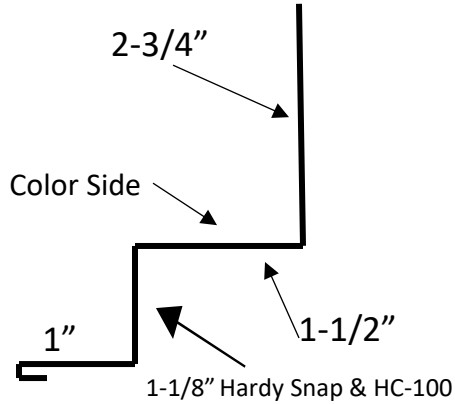

1-3/8" Legacy Hardy Clip

1-5/8" Hardy Loc, HC-150, & HS-150

EX-End/Head Wall 10'

Non-Returnable

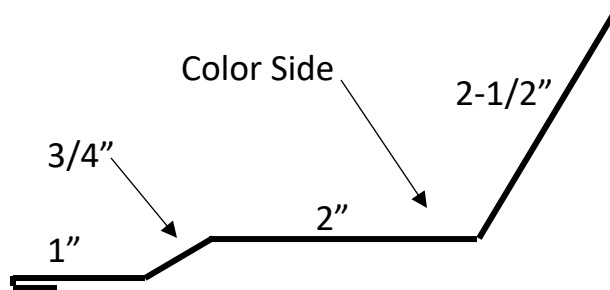

EX-Outside Transition 10'

Non-Returnable

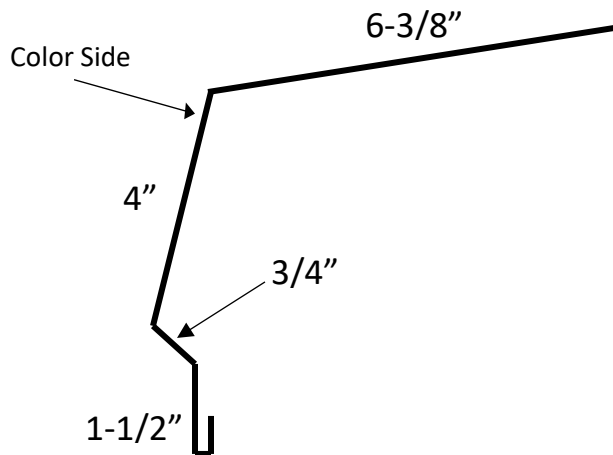

EX-Outside Corner 10'

Non-Returnable

